

The control unit design and study for urea hydrolysis SCR System

QI ZHANFENG^{2,4}, LI SHUSEN², GUO XIULI³

Abstract. Due to the serious pollution, the reduction of NO_x emissions from diesel engines is imminent. Based on the characteristics analysis of selective catalytic reduction (SCR) and the mechanism analysis of urea hydrolysis by mobile source, the hardware and software design and bench test of urea hydrolysis SCR control system, the study of urea denitrification reactor for SCR hydrolysis was carried out. Its control unit using Renesas' 32-bit RISC microcontroller UPD70F3380 to reduce nitrogen oxides (NO_x) emission of the diesel engine was developed. The hardware circuit of microcontroller unit (MCU) module, power management module, analog signal acquisition circuit, and so on, were designed. The control strategy was developed on the basis of the working principle of SCR, and the control program was designed and perfected. The emission test of the European steady-state cycle (ESC) and the European transient cycle (ETC) was carried out on the JX493ZLQ3 diesel engine. The test results showed that the brake-specific emission of NO_x was 1.887 g/(kW h) and 1.919 g/(kW h) in the ESC and ETC, respectively. The maximum ammonia leakage was less than 10 ppm. The NO_x emission of diesel engine could meet the National Emission Standard V. In conclusion, the control unit was stable and met the design requirements.

Key words. Control strategy; control unit, selective catalytic reduction, urea hydrolysis.

1. Introduction

The selective catalytic reduction (SCR) technology has been widely used in place Europe because of its higher fuel economy and good sulfur tolerance [1]. The SCR technology in place country-region China is also in the popularization and application stage. The technology behind ammonia (NH_3) production is urea pyrolysis and hydrolysis. Therefore, urea pyrolysis and hydrolysis SCR systems were formed [2]. The pyrolysis SCR system is related to nitric oxides (NO_x) concentration, cat-

¹Acknowledgement - This work is supported by the National Natural Science Foundation of China (51306025) and the Fundamental Research Funds for the Central Universities (2572015AB13).

²Workshop 1 - College of Mechanical and Electrical Engineering, Northeast forestry university, Heilongjiang, Harbin 150000, China

³Workshop 2 - College of Mechanical Engineering, Dalian University, Liaoning, Dalian 116000, China

⁴Corresponding author: Qi Zhanfeng

alyst, reductant, and so on. The supply of reducing agent needs to dynamically consider the concentration of NO_x , the working conditions of the catalyst, and the leakage of NH_3 . Therefore, the control of reducing agent injection is an important issue in the application of urea pyrolysis SCR [3]. In contrast, no difference is found in the catalyst structure of urea pyrolysis SCR system, but the structure of the reducing agent is different. Therefore, the application of the urea hydrolysis SCR system focuses on the control of urea supply.

This study introduced the diesel engine urea hydrolysis SCR system with independent intellectual property rights. It also explored the system structure, hardware development, and control strategy of urea dosing control unit (DCU) and the matching calibration and test results of DCU on the engine and urea SCR aftertreatment system.

2. Urea hydrolysis SCR system

The basic structure of urea pyrolysis SCR system included the following main parts [4]: a DCU unit of the integrated control system, a urea metering pump, a nozzle, a catalytic converter (containing carrier and catalyst), a urea tank, a heating water valve, a heating resistance wire, and various sensors. Its basic structure is shown in Fig. 1.

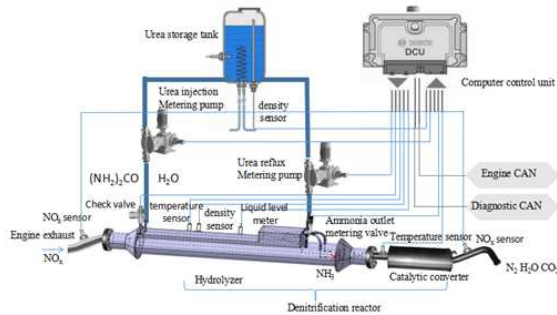

Fig. 1. Urea hydrolysis SCR system

The working principle of the urea hydrolysis denitrification reactor was as follows. When the system worked, the DCU electronic control unit (ECU) communicated with the ECU of the engine through the controller area network (CAN) bus. The current speed, load, engine intake flow, and other information were obtained. The temperature sensor signal before the catalytic converter, urea temperature, and density sensor signal were collected and processed.

Then, the storage control strategy was used to calculate the mass flow rate of the product gas (gas produced by urea hydrolysis, including carbon dioxide (CO_2), water (H_2O), NH_3 , and so on). The NH_3 outlet metering valve was opened according to the requirement, and the NH_3 gas was injected into the exhaust pipe. At the same time, the motor drive of the urea injection metering pump or the urea reflux metering pump was operated according to the required speed, and the urea solution

was filled or discharged in the hydrolysis chamber. Urea was hydrolyzed in the high-temperature environment of the hydrolysis chamber, and the NH_3 gas was mixed with the tail gas before entering the catalytic converter. The NO_x in the tail gas was reduced to nitrogen (N) and H_2O under the action of the catalyst.

3. DCU system structure

The system structure of DCU is shown in Fig. 2. It mainly included a microcontroller, a power module, a CAN communication module, and a signal input/output module. The main input and output signals were summarized as follows.

The input signal included six-channel analog signals, including the catalytic converter exhaust upstream temperature, two-channel pump pressures and temperature, density, and liquid level during urea hydrolysis in the urea solution, through the acquisition of analog-to-digital (AD) conversion circuit access system port.

The output signal included three-channel PWM signal, including two-channel stepper motor drives of the urea metering pump and product gas metering valve drive, through the power amplifier circuit output.

DCU had a large number of digital input and output, analog input and output, and external communication functions. Therefore, the controller components needed to consider the reliability, scalability, ease maintenance, and other factors. Mature components were selected to meet the complex and stringent environmental requirements of the vehicle [5].

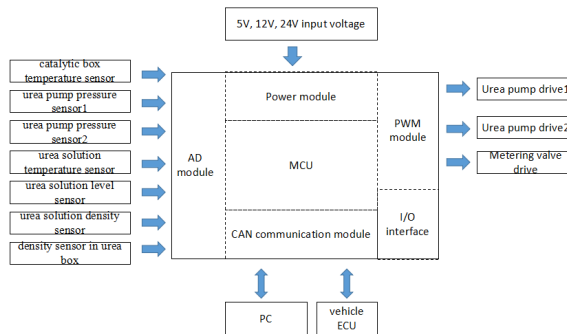

Fig. 2. Block diagram of DCU system structure

3.1. Microcontroller unit

SCR postprocessing control unit was a microprocessor using the single chip as the core. MCU was the core component of the DCU, and realized the DCU control strategy by sampling and controlling the sensors and actuators through a variety of peripheral circuits [6]. The MCU must have seven AD conversion channels, at least three-channel PWM output, input capture and output, and at least two high-speed CAN communication modules connected with the vehicle ECU and PC

communication. The MCU was less expensive. Therefore, the Renesas 32-bit RISC microcontroller UPD70F3380 single chip was selected.

3.2. Power module

The SCR system used the vehicle battery as power. The nominal voltage of the diesel vehicle battery was 24 V, but the input voltage of the MCU was 5 V and that of the sensor processing circuit was 12 V. Therefore, the upper limit of the input voltage was high enough. At the same time, due to the complex and changeable working condition of the engine, it was required that the system should maintain the voltage stability under the condition of various loads and have the ability to make a large-enough current pass through to improve the stability of the system.

The buck regulator (LM2674 and LM2676) was used to convert the 24 V voltage into 5 V and 12 V voltage output to ensure the normal operation of the system in a broad range of voltage changes. The two-way power supply includes diode, capacitance, and resistance, which constituted the anti-reverse protection circuit.

3.3. CAN communication module

The communication between the control system and the peripheral device of the denitrification reactor was realized by the CAN bus. The communication objects included engine ECU, NO_x sensor, and host computer. In CAN networks, the nodes needed to have CAN controllers and CAN transceivers simultaneously. Among them, the CAN controller performed the analysis and conversion of the CAN protocol, converted the CAN frame into the binary bitstream, transmitted through the transceiver, and received the packet filtering from the transceiver. The CAN controller was divided into two independent controller chips integrated into the microcontroller. This system used a CAN controller integrated into the microcontroller UPD70F3380. The CAN transceiver was the interface between the CAN controller and the physical bus that performed the conversion between the logic level of the CAN controller and the differential level of the bus. This system adopted high-speed CAN transceiver chip TJA1040. TJA1040 was the interface between the CAN protocol controller and the physical bus, and the speed was up to 1 Mbaud. The TJA1040 performed differential transmit function for the bus, providing differential reception for the CAN controller. TJA1040 had excellent EMC performance and ideal passive performance without power on. It could also provide low-power management and support remote wakeup. The mode of information transfer between CAN devices was described by communication protocols. SAE J1939 is a recommended standard of the American Automotive Engineering Association, which provides standard structural definitions for communications between electronic devices on medium and heavy road vehicles. Most of the heavy vehicle communication protocols are based on SAE J1939 [7], and the CAN communication of this control system was based on this standard.

3.4. Analog signal acquisition circuit

The analog signal acquisition circuit was responsible for processing the measured value of the sensor into the voltage value of the 0–5 V range and then inputting the AD pin of the MCU, mainly used to deal with urea solution temperature sensor signal, urea solution level sensor signal, catalytic box temperature sensor signal, urea pump pressure sensor signal, urea solution density sensor signal, and so on. At the same time, it was necessary to denoise the sensor signal and make the voltage limiting protection because of the strong signal interference in the engine working environment. It prevented the main chip from being damaged by harmful signals in any case [8]. The circuit designed in this study had the functions of signal amplification, resistance capacitance filter, voltage limiting protection, and so on, to ensure the correct acquisition of the input analog signal.

4. Reresearch on DCU control strategy

The amount of NH_3 required by the urea hydrolysis SCR system must be injected regularly and quantitatively according to the working conditions of the engine [9]. It was necessary to provide the appropriate control strategy for the urea supply system to realize the accurate control of the NH_3 flow. It was also necessary to follow the amount of NH_3 injected for adjustment [10].

Therefore, the focus of the urea hydrolysis SCR system control strategy was on the control of urea supply. It then controlled the amount of NH_3 produced by controlling the supply of urea. Therefore, the whole control was actually divided into two levels. The first stage was to control the discharge of NH_3 , and the second to control the supply of urea. The control system strategy of urea hydrolysis SCR needed to consider a variety of processes; the goal was to minimize the emission of NO_x and avoid the NH_3 escape under all boundary conditions [11]. Fig. 3 shows the schematic diagram of the DCU control strategy.

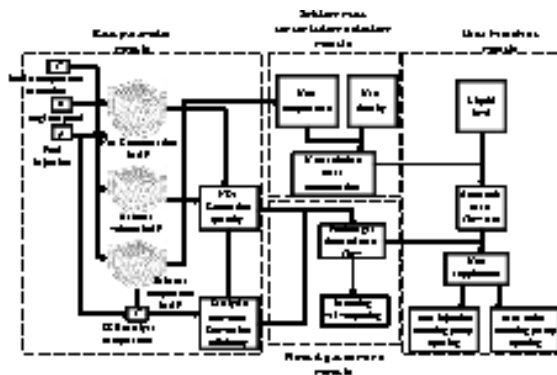

Fig. 3. Schematic diagram of DCU control strategy

As shown in Fig. 3, the basic idea behind the control of urea supply was as follows.

First of all, the NO_x concentration in the exhaust, exhaust volume, and exhaust temperature were obtained according to the engine operating conditions (speed, percentage of torque) by checking the engine static MAP diagram. Thus, the molar flow of NO_x was calculated. The basic demand of NH_3 was modified according to the conversion efficiency of the catalyst, catalyst carrier temperature of NH_3 , space velocity, and so on, to determine the mass flow rate of NH_3 in each engine cycle and adjust the NH_3 export metering valve opening. Then, the urea temperature, urea density, and urea pressure in the hydrolysis chamber were measured by the sensor. The mass concentration of urea solution was calculated according to the measured value. Finally, the mass flow rate of NH_3 was calculated according to the real-time mass concentration of urea solution and the height of liquid in the hydrolysis chamber. This value was compared with the mass flow parameter of NH_3 demand, and the opening degree of the urea injection metering pump or the urea reflux metering pump was adjusted on the basis of the result. Fig. 4 shows the basic logic diagram of the control method of SCR system for urea hydrolysis.

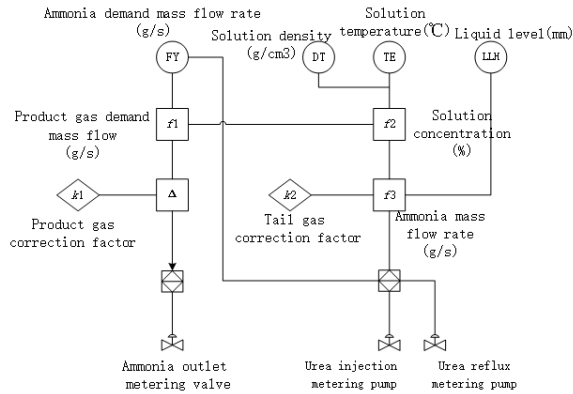

Fig. 4. Logic diagram of the control method of the denitration reactor

As shown in Fig. 4, the automatic control of the executive body was via the NH_3 outlet metering valve, urea inject metering pump, and urea reflux metering pump.

The measurement data of the urea hydrolysis reaction control included the temperature of urea solution in the hydrolysis chamber, density of urea solution, tail gas flow rate, demand mass flow rate of NH_3 , and so on. Among them, the demand mass flow rate of NH_3 was calculated according to the MAP diagram of NO_x emission of the diesel engine. The functions involved in the control included $f1$, $f2$, and $f3$, and the specific functions were shown separately as (1), (2), and (3), respectively.

When the urea concentration was different, the relationship between the demand mass flow rate of the product and the demand mass flow rate of NH_3 was $f1$, which could be expressed as:

$$Q_{\text{product}} = (Q_{\text{NH}_3} \times 1.7647) / w \quad (1)$$

where Q_{product} is the mass flow rate of urea hydrolysis reaction product gas

demand, Q_{NH_3} is the mass flow rate of NH_3 demand, and w is the concentration of urea solution.

At different temperatures, the relationship between the density and mass concentration of urea solution was f_2 , which could be expressed as:

$$w = 2.71 \times 10^3 t - 4.2 + (7.36 \times 10^6 t^2 + 29.72t + 26.31\rho - 12.12)^{0.5} \quad (2)$$

where t is the urea solution temperature during urea hydrolysis and ρ is the urea solution density.

Under different temperature conditions, the NH_3 mass flow function, which was produced by urea hydrolysis under different urea concentration, was f_3 .

$$Q_{NH_3} = \frac{M_e C_e - M_0 C_0}{60.06 \times 2 \times \tau} \times 17.031 \quad (3)$$

where M_e is the quality of urea solution at the end of the working condition, M_0 is the quality of urea solution at the beginning of the working condition, C_e is the concentration of urea solution at the end of the working condition, C_0 is the concentration of urea solution at the beginning of the working condition, and τ is the duration of the working condition. The quality of urea solution was obtained using two parameters of urea solution density and liquid level.

The mass flow rate was obtained through the real-time detection and accurate calculation of the parameters of the urea hydrolysis denitrification reactor. The opening of the NH_3 outlet metering valve, urea injection metering pump, and urea reflux metering pump were controlled. The operation of the diesel engine in the urea hydrolysis system was followed.

5. SCR system matching and compliance test

In this study, urea SCR aftertreatment system was developed for JX493ZLQ3 diesel engine. The engine parameters are shown in Table 1. The catalyst used in the SCR aftertreatment system was $V_2O_5-WO_3-TiO_2$, with a catalyst size of $22 \times 21 \text{ cm}^2$ (diameter \times length) and the total volume of 7.9 L. The catalyst inlet temperature sensor was an HICTS08-02 temperature sensor, and the density sensors of the urea tank and the hydrolysis chamber were WS3051-X-YC density sensors.

Urea injection metering pump and urea reflux metering pump were measured by KCP-C-DAB06 metering pump; the maximum flow rate was 2 L/h. The NH_3 outlet metering valve was a model of WL91H-320U metering valve, and the control accuracy was 0.18%. The arrangement of the whole SCR system on the engine bench is shown in Fig. 5.

Table 1. Performance parameters of JX493ZLQ3 diesel engine

Name	Parameter value
Engine type	Water cooled, four stroke, in-line, super-charging middle cooling common rail
The number of cylinders	4
Bore	93mm
Stroke	102mm
Emission standard	National 3rd standards
Firing order	1342
Rated speed	3600r/min
Compression ratio	17.2
Displacement	2.771L
Rated power	85kW
Rated torque	285N m
Lubricating oil capacity	3.78L

NO_x emission MAP diagram and exhaust flow MAP diagram were obtained through the engine emission test, as shown in Fig. 6, Fig.7. and Fig. 8 shows the catalyst conversion efficiency MAP diagram.



Fig. 5. Engine bench with urea hydrolysis SCR treatment

Based on the existing experimental conditions, the ESC and ETC tests of the JX493ZLQ3 diesel engine equipped with a self-designed denitrification reactor were carried out to verify the performance of the SCR system. Fig. 9 shows the NO_x concentrations at the inlet and outlet of the denitrification reactor. The operating conditions were disrupted and arranged according to speed A, B and C to facilitate analysis.

As can be seen from Fig. 9, the NO_x emission decreased gradually during the

Fig. 6. NO_x emission map diagram of diesel engine

Fig. 7. exhaust flow map diagram

increase of speed A to speed C. NO_x emissions increased gradually with the increase in load. This phenomenon also supported the law that the concentration of NO_x emission increases first and finally stabilizes with the increase in engine torque. This is because, under same conditions, the greater the output torque, the higher the combustion temperature in the cylinder, conducive to the formation of NO_x . In the ESC test, the amount of NO_x emission from the denitrification reactor was 1.887 g/(kW h), which was lower than the NO_x emission limit of 2.0 g/(kW h) set by the National Emission Standard V.

The purpose of the ETC test was to test the dynamic performance of the exhaust aftertreatment unit [12]. Fig. 10 shows the comparison of the cycle concentration of the diesel without and with the denitrification reactor. As can be seen from Fig. 10, the concentration of NO_x decreased obviously, and the conversion efficiency of NO_x was higher after the application of the denitrification reactor. The ETC test results without the denitrification reactor for the diesel engine using Euro IV standard oil showed that the NO_x -specific emission was 4.886 g/(kW h). The test result with the

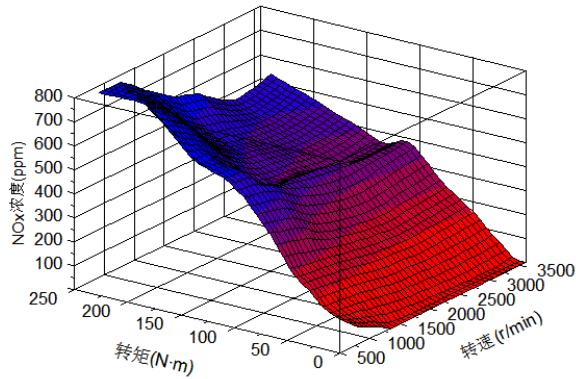
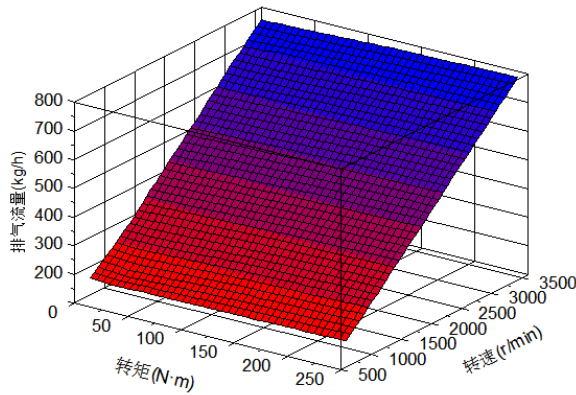
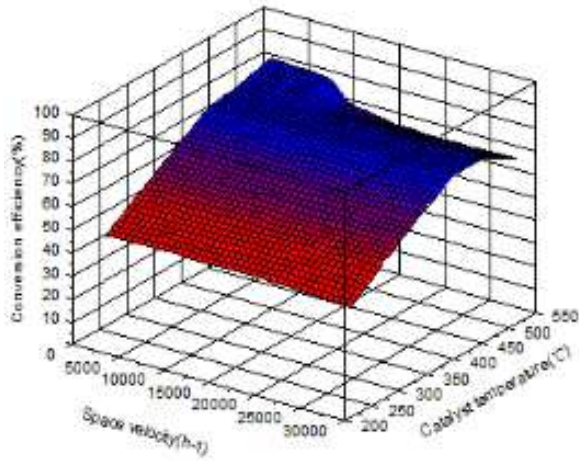

Fig. 8. MAP diagram of catalyst conversion efficiency

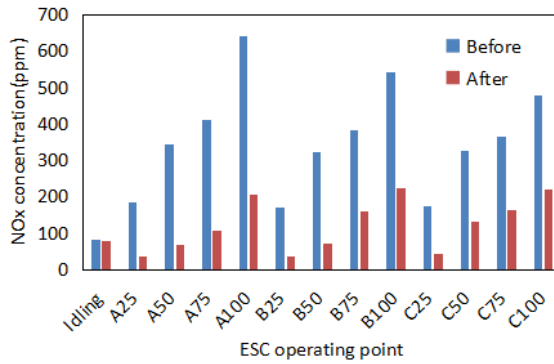

Fig. 9. NO_x concentration before and after denitrification reactor

denitrification reactor showed that the NO_x-specific emission was 1.919 g/(kW h). The average slip loss of NH₃ was less than 10 ppm in the test of Euro IV standard oil. Table 3 shows the ESC and ETC test results.

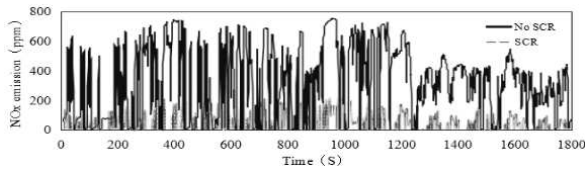

Fig. 10. Comparison of ETC test results with or without SCR

Table 3. ESC and ETC test results

Parameter	CO/g (kW/h) ⁻¹		HC/g/ (kW/h) ⁻¹		NO _x /g/ (kW/h) ⁻¹		PM/g/ (kW/h) ⁻¹		NH ₃ /10 ⁻⁶	
	ESC	ETC	ESC	ETC	ESC	ETC	ESC	ETC	ESC	ETC
Measured value	0.044	0.089	0.012	0.023	1.887	1.919	0.016	0.026	-	6
Nationa IV	1.5	4.0	0.46	0.55	3.5	3.5	0.02	0.03	-	25
National V	1.5	4.0	0.46	0.55	2.0	2.0	0.02	0.03	-	25

6. Conclusion

(1) The brake-specific emission of NO_x in DCU developed in this study was 1.887 g/(kW/h) and 1.919 g/(kW/h) in the ESC and ETC, respectively. The maximum NH₃ leakage was 6 ppm. It ensured that the urea SCR aftertreatment system could meet the requirement of the emission limits of diesel engines.

(2) The DCU had the advantages of compact structure and reliable operation, adopted the dynamic two-level control strategy based on the MAP diagram, and reduced the cost of the whole urea SCR aftertreatment system, which was consistent with the requirements of the domestic diesel aftertreatment system.

References

- [1] J. S. TOMAR, D. C. GUPTA, N. C. JAIN: *Equilibrium and kinetic studies of in situ generation of ammonia from urea in a batch reactor for flue gas conditioning of thermal power plants*. Industrial & engineering chemistry research 15 (1984), No. 2, 211–220.
- [2] J. S. TOMAR, A. K. GUPTA: *Development, application and direction of development of urea-SCR*. International journal of multimedia and ubiquitous engineering 98 (1985), No. 2, 257–262.
- [3] R. H. GUTIERREZ, P. A. A. LAURA: *Experimental investigation of combined LNT+SCR diesel exhaust aftertreatment*. Emission control science and technology 18 (1985), No. 3, 171–180.
- [4] R. P. SINGH, S. K. JAIN: *Influential factors on NO_x conversion efficiency of vehicle SCR system*. Transactions of CSICE 7 (2004), No. 1, 41–52.
- [5] M. N. GAIKWAD, K. C. DESHMUKH: *Kinetic studies on hydrolysis of urea in a semi-batch reactor at atmospheric pressure for safe use of ammonia in a power plant for flue gas conditioning*. Journal of hazardous materials 29 (2005), No. 9, 797–804.
- [6] S. CHAKRAVERTY, R. JINDAL, V. K. AGARWAL: *Modelling of a combined NO_x storage and NH₃-SCR catalytic system for diesel exhaust gas aftertreatment*. Catalysis today 12 (2005) 521–528.
- [7] N. L. KHOBRAGADE, K. C. DESHMUKH: *Hideki Matsunaga and Yuji Yasui, New urea-SCR control system for super clean diesel*. Journal of robotics and mechatronics 30 (2005), No. 4, 555–563.
- [8] Y. F. ZHOU, Z. M. WANG: *Preparation and characterization of V₂O₅ doped SiO₂-TiO₂ thin films*. Central european journal of engineering 316 (2008), Nos. 1–5, 198–210.
- [9] R. LAL: *Characteristics of urea hydrolysis equipment for flue gas denitration*. Proceedings of the csee 34 (2003), No. 4, 587–606.

- [10] R. LAL, Y. KUMAR: *Experimental Investigation on the properties of urea thermohydrolysis with catalysts*. Proceedings of the csee 20, (2013), No. 4, 264–275.
- [11] Y. KUMAR: *A new air-fuel ratio control for a high-efficiency and low-emission engine*, *SICE J. of control, measurement. and system integration* 18 (2013), No. 2, 589–597.
- [12] J. R. KUTTLER, V. G. SIGILLITO: *Study of NOx reduction behavior on iron ion-exchanged zeolite catalyst for ULEV50*. Honda technical review 78 (1981), No. 4, 585–590.

Received November 16, 2017